

ใบตรวจสอบ Plunger

190 x 190 x 50

รุ่น _____ No. _____ แบบบ่อ แบบหลอด

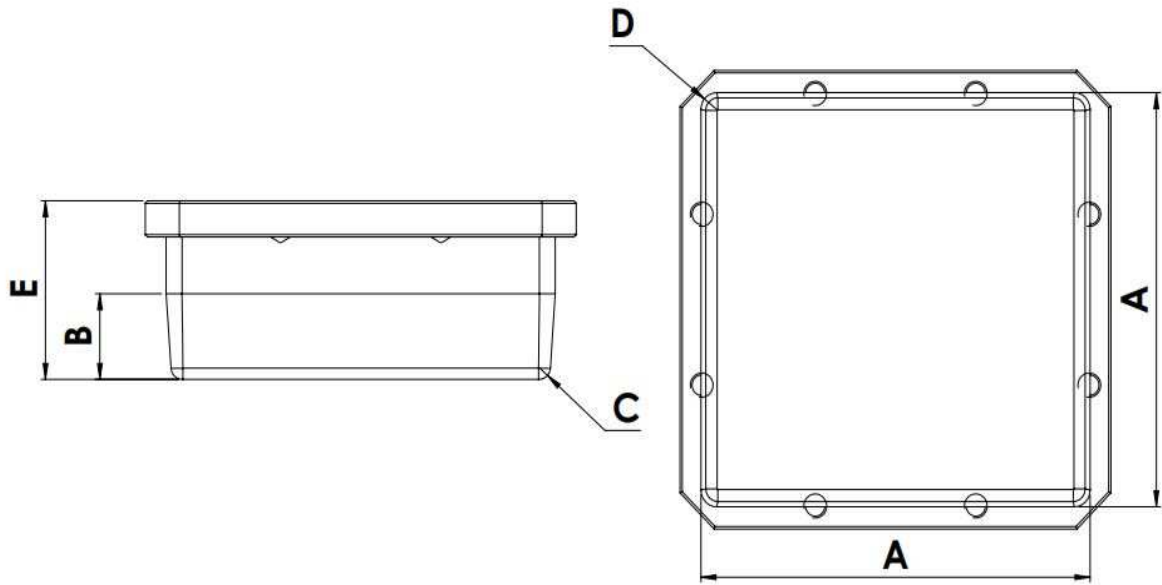

วันที่ใช้งาน																				
วันที่เปลี่ยนออก / สาเหตุ																				

point	dim.	tol.(+)	tol.(-)																	
A	169.18	169.38	168.98																	
	169.18	169.38	168.98																	
B	31.00	31.20	30.80																	
C	R5	R5.2	R4.8																	
D	R7	R7.2	R6.8																	
E	95	95.2	94.8																	
ความเรียบร้อยผิวงาน																				
ผ่าน																				
ไม่ผ่าน																				

Record																				
Approve																				